

J-61 - Enlace mixto rosca macho

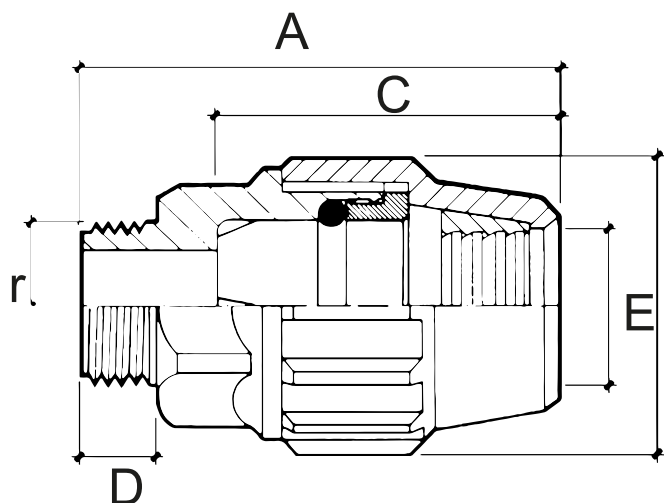

Referencia	Medidas	Carac.	u./caja
055001	50-1 1/2"	N AENOR	25
055002	63-2"	N AENOR	25
055011	20-1/2"	N AENOR	100
055012	25-3/4"	N AENOR	100
055013	32-1"	N AENOR	100
055014	40-1 1/4"	N AENOR	100
055015	75-2 1/2"	-	5
055016	90-3"	-	5
055132	20-3/4"	N AENOR	50
055133	25-1/2"	N AENOR	50
055147	16-1/2"	-	50
055148	16-3/8"	-	50
055192	110-4"	-	2
055213	25-1"	N AENOR	50
055214	32-3/4"	N AENOR	50
055215	32-1 1/4"	N AENOR	50
055216	40-1"	N AENOR	50
755011	20-1/2"	Uds. Venta reducida	50
755012	25-3/4"	Uds. Venta reducida	25
755013	32-1"	Uds. Venta reducida	25
755132	20-3/4"	Uds. Venta reducida	25
755133	25-1/2"	Uds. Venta reducida	25
755213	25-1"	Uds. Venta reducida	25
755214	32-3/4"	Uds. Venta reducida	20

Cotas



Referencia	A	B	C	D	E	medida/size	r
055001	142	88	110.7	24.6	51.4	50-11/2"	1 1/2"
055002	164	110	124	31.5	64.3	63-2"	2"
055011	68.5	41	52	10.6	20.8	20-1/2"	1/2"
055012	84.4	47.8	63	15.2	25.6	25-3/4"	3/4"
055013	95.5	58	68.5	14.8	33	32-1"	1"
055014	119.5	69.5	87	20	41.4	40-11/4"	1 1/4"
055015	186	121	133	30	79.3	75-21/2"	2 1/2"
055016	207	146.5	164	33.4	91.5	90-3"	
055132	68.5	41	52	15.6	20.8	20-3/4"	3/4"
055133	84.4	47.8	63	11.9	25.6	25-1/2"	1/2"
055147	59.7	33.5	41.5	14.5	17	16-1/2"	1/2"
055192	233	178	180	39.3	117	110-4"	4"
055213	85.2	47.8	63	16	25.6	25-1"	1"
055214	94.7	58	68.5	15.2	33	32-3/4"	3/4"
055215	99.5	58	68.5	20	33	32-11/4"	1 1/4"
055216	115.5	69.5	87	16	41.4	40-1"	1"

Documentación



Instrucciones

Tarifas



Certificados



Para más información visite la dirección <https://www.jimten.com/es/producto/2922/enlace-mixto-rosca-macho/>

Ctra. de Ocaña, 125 C.P. 03114, 5285 C.P. 03080 Alicante, España +34 965 109 044, Fax +34 965 11 50 82 España & Portugal:
comercial@jimten.com - Export: international@jimten.com

