

## S-247 - Caldereta sifónica extensible autolimpiante salida vertical macho encolar



Referencia	Medidas	Carac.	u./caja
008182	75-150X150	Gris	10
008190	90200X200	Negro	10
008192	90-200X200	Gris	10
008200	110200X200	Negro	6
008240	90250X250	Negro	6
008242	90-250X250	Gris	6
008250	110250X250	Negro	5
008252	110-250X250	Gris	5
008300	125300 X 300	Negro	4
008202	110-200X200	Gris	6
008180	75150 X 150	Negro	10



ECO-PVC Sin Plomo



Autolimpiante

Caldereta sifónica extensible, salida vertical macho encolar.

**Diseñados de acuerdo a la EN 1253:**

Sello hidráulico de 50mm.

**Resistencia a la carga:**

Conforme a DIN 19599. Sumideros y cubiertas en edificios Clase L15.

## Cotas

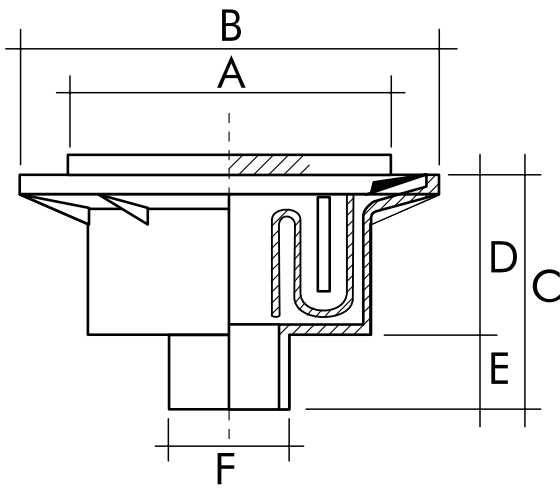

Referencia	(Q)	A	B	C	D	E	ØF
008182	> 1,36 l/s	150x150	222	127	80	47	75
008190	> 2,42 l/s	200x200	293	155	97	58	90
008192	> 2,42 l/s	200x200	293	155	97	58	90
008200	> 2,42 l/s	200x200	293	155	97	58	110
008240	> 2,67 l/s	250x250	350	147	97	50	90
008242	> 2,67 l/s	250x250	350	147	97	50	90
008250	> 2,68 l/s	250x250	350	147	97	50	110
008252	> 2,68 l/s	250x250	350	147	97	50	110
008300	> 2,88 l/s	300x300	425	180	125	55	125
008202	> 2,42 l/s	200x200	293	155	97	58	110
008180	> 1,36 l/s	150x150	222	127	80	47	75

## Documentación



## Tarifas



## Certificados



Para más información visite la dirección <https://www.jimten.com/es/producto/6274/caldereta-sifonica-extensible-autolimpiante-salida-vertical-macho-encolar/>

