



Referencia	Medidas	Carac.	u./caja
032036	110	Teja	4
032037	125	Teja	4
032152	110	Gris	4
032227	125	Gris	4



ECO-PVC Sin Plomo

Sifón con registro macho/hembra, con junta labiada

Cotas

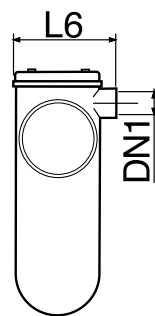
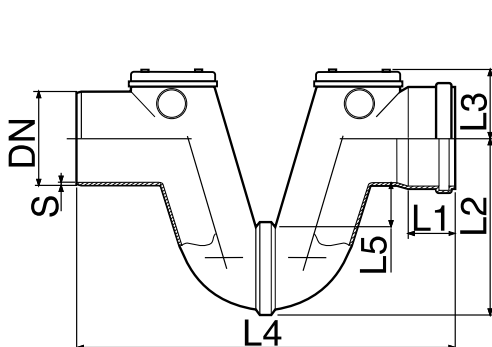

Referencia	DN	DN1	L1	L2	L3	L4	L5	L6	S	Ø Registro
032036	110	40	61	202	88	495	35	153	3.0	141
032037	125	40	62	235	92	490	38	175	3.0	155
032152	110	40	61	202	88	495	35	153	3.0	141
032227	125	40	62	235	92	490	38	175	3.0	155

Documentación



Tarifas



Certificados



Para más información visite la dirección <https://www.jimten.com/es/producto/1828/sifon-en-linea-mh-con-registros/>

